

5 Caring for Your Camera

TRANSPORTING YOUR CAMERA

The Matterport Pro2 3D Camera is sensitive and carefully calibrated. Always transport your camera in a padded carrying bag or case and handle with care. When transporting in a vehicle, ensure that the camera is secured and will not shift.

If traveling by air, we recommend keeping the camera in your carry-on luggage. If you must transport the camera in checked luggage, use a hard, padded case with foam inserts. Always ship your camera in the original padded shipping box provided by Matterport.

LENS CARE

Treat your Matterport Pro2 3D Camera lenses as you would DSLR lenses. When necessary, remove dust from your lenses using a small, bulb-style hand air pump with a soft lens brush. Remove fingerprints from lenses with camera lens cleaner and a microfiber cloth. Always clean by first dusting the lens, then applying cleaner to the cloth (not directly to the lens).

STORAGE & TEMPERATURE

Do not use or leave the camera at very high temperatures. For example, in strong direct sunlight or in a vehicle in extremely hot conditions. The battery performance will be degraded and its service life will be decreased.

The camera should be stored at room temperature. If the camera is not used regularly, then take it out once every 3 months and charge it. If in storage for longer than a year, then the camera should be fully discharged and recharged.

6 Specifications

Input Voltage	15 V  from Matterport Power Supply only
Battery Type	Lithium-Ion Battery
Battery Capacity	~8 Hours (continuous use)
Charge Time	~4.5 Hours
Weight	Approx. 3.5 kg (7.6 lbs)
Dimensions (H x W x D)	Approx. 229 x 260 x 111 mm (9.0 x 10.25 x 4.38 in)
Color	Black
Wireless Connection	WiFi 802.11 n/ac 5 GHz The available modes may be restricted in your country
Mounting Connections	Female 3/8-16 thread Acra-Swiss style quick release
Operating Temperature	10 - 32° C
Storage Temperature	0 - 40° C

MC250 Camera Power Supply	
Input Voltage	100 - 240 V
Input Current	2 Amps
Input Frequency	50/60Hz
Output Voltage	15 V 
Output Current	6 Amps

COMPLIANCE
 European Compliance
 Conforms to the following Standards:

Document No.	Title
EN 301 489-1	Radio Equipment, EMC, Common Technical Requirements
EN 301 489-17	Radio Equipment, EMC, Specific conditions for Broadband Data TX Systems
EN 301 893	5 GHz high performance RLAN; Harmonized EN covering essential requirements of article 3.2 of the RED Directive
EN 55032	Electromagnetic Compatibility, Class B Emissions
EN 55024	Electromagnetic Compatibility, Immunity
EN 60950-1	Information Technology Equipment, safety

Following the provisions of the following Directives:

2014/30/EU	EMC Directive
2014/35/EU	Product Safety Directive
2014/53/EU	Radio Equipment Directive
2012/19/EU	Directive on Waste Electrical and Electronic Equipment
2006/66/EC	Batteries and Accumulators Waste Batteries Directive
2011/65/EU	Restriction of Hazardous Substances (RoHS) Directive

Australian Standards:

EN 301 489-1	Radio Equipment, EMC, Common Technical Requirements
EN 300 489-17	Radio Equipment, EMC, Specific conditions for Broadband Data TX Systems
EN 301 893	5 GHz high performance RLAN; Harmonized EN covering essential requirements of article 3.2 of the RED Directive
EN 55032	Electromagnetic Compatibility, Class B Emissions
AS/NZS 60950-1	Information Technology equipment, safety
AS/NZS 4268	Radio Equipment and Systems - Short Range devices - Limits and methods of measurement

Japanese Radio Notice:
 警告 この装置は、クラスB情報技術装置です。この装置は、家庭環境で使用することを目的としていますが、この装置がラジオやテレビジョン受信機に近接して使用されると、受信障害を引き起こすことがあります。取扱説明書に従って正しい取り扱いをして下さい。WCC1-B

FCC WARNING
 This device complies with Part 15 of the FCC Rules. Operation is subject to the following two conditions: (1) this device may not cause harmful interference; and (2) this device must accept any interference received, including interference that may cause undesired operation. This equipment has been tested and found to comply with the limits for a Class B digital device, pursuant to part 15 of the FCC Rules. These limits are designed to provide reasonable protection against harmful interference in a residential installation. This equipment generates, uses, and can radiate radio frequency energy and, if not installed and used in accordance with the instructions, may cause harmful interference to radio communications. However, there is no guarantee that interference will not occur in a particular installation. If this equipment does cause harmful interference to radio or television reception, which can be determined by turning the equipment on and off, the user is encouraged to try to correct the interference by one or more of the following measures:

- Reorient or relocate the receiving antenna.
- Increase the separation between the equipment and receiver.
- Connect the equipment into an outlet on a circuit different from that to which the receiver is connected.
- Consult Matterport or an experienced radio/TV technician for help.
- Changes or modifications not expressly approved by Matterport could void the user's authority to operate the equipment.

INNOVATION, SCIENCE AND ECONOMIC DEVELOPMENT (ISED) CANADA
 This device complies with Industry Canada license-exempt RSS standard(s). Operation is subject to the following two conditions: (1) this device may not cause interference, and (2) this device must accept any interference, including interference that may cause undesired operation of the device. Le présent appareil est conforme aux CNR d'Industrie Canada applicables aux appareils radio exempts de licence. L'exploitation est autorisée aux deux conditions suivantes : (1) l'appareil ne doit pas produire de brouillage, et (2) l'utilisateur de l'appareil doit accepter tout brouillage radioélectrique subi, même si le brouillage est susceptible d'en compromettre le fonctionnement.

WARRANTY
 Limited Warranty. Matterport warrants the Camera against defects in material and workmanship for a period of one (1) year from original date of shipment, or such longer period under any extended warranty purchased by You at Matterport's then-available extended warranty rate (collectively, the "Warranty Period"). This limited warranty is for the benefit of the original purchaser only and is not transferable. THIS LIMITED WARRANTY IS IN LIEU OF ALL OTHER WARRANTIES OF QUALITY AND PERFORMANCE, WRITTEN, ORAL OR IMPLIED, INCLUDING ANY IMPLIED WARRANTY OF MERCHANTABILITY OR FITNESS FOR A PARTICULAR PURPOSE. THIS LIMITED WARRANTY SHALL NOT APPLY IF THE CAMERA HAS BEEN REPAIRED OR ALTERED, EXCEPT BY MATTERPORT, OR IF IT HAS BEEN SUBJECTED TO MISUSE, NEGLIGENCE, OR ACCIDENT. In the event any defect in the material or workmanship of the Camera arises during the Warranty Period, Matterport's sole liability shall be (at the option of Matterport) to repair, provide a refund for, or replace any Camera returned by You during the Warranty Period, provided that (a) Matterport is notified in writing by You of the claimed defect(s) during the Warranty Period, (b) the Camera is returned to Matterport in the undamaged original Camera packaging, and (c) Matterport's examination of the Camera discloses to its satisfaction that the defect(s) were not caused by misuse, negligence, accident, or unauthorized repair or alteration by You or on Your behalf. All shipping costs to Matterport from any location in the United States, or from Matterport to any location in the United States, for any Camera that is repaired or replaced under this limited warranty, will be at Matterport's expense; provided, however, that You will bear the expense of shipping any such Camera to or from any non-U.S. location. MATTERPORT'S ONLY LIABILITY AND YOUR EXCLUSIVE REMEDY FOR ANY CLAIM OF A DEFECT IN THE CAMERA, WHETHER ARISING IN TORT OR CONTRACT, IS AS STATED IN THIS SECTION 5. IN NO EVENT SHALL MATTERPORT OR ITS AFFILIATES OR LICENSORS BE LIABLE FOR ANY LOSS OR DAMAGE, WHETHER IN CONTRACT, TORT (INCLUDING, BUT NOT LIMITED TO, NEGLIGENCE), BREACH OF STATUTORY DUTY, OR OTHERWISE, EVEN IF FORESEEABLE, ARISING UNDER OR IN CONNECTION WITH THIS AGREEMENT. IN PARTICULAR, MATTERPORT SHALL NOT BE LIABLE FOR (A) LOST PROFITS, (B) LOST DATA, (C) LOSS OF BUSINESS, GOODWILL OR REPUTATION, OR (D) FOR ANY OTHER SPECIAL, EXEMPLARY, PUNITIVE, INDIRECT, INCIDENTAL OR CONSEQUENTIAL DAMAGES OF ANY KIND, EVEN IF MATTERPORT HAS BEEN ADVISED OF THE POSSIBILITY OF SUCH DAMAGES. IN NO EVENT WILL THE TOTAL CUMULATIVE LIABILITY OF MATTERPORT AND ITS AFFILIATES AND LICENSORS UNDER THIS AGREEMENT FROM ALL CAUSES OF ACTION OF ANY KIND, INCLUDING TORT, CONTRACT, NEGLIGENCE AND STRICT LIABILITY, EXCEED THE LESSER OF THE TOTAL AMOUNTS YOU PAID TO MATTERPORT UNDER THIS AGREEMENT DURING THE SIX (6) MONTHS PRECEDING YOUR CLAIM(S), OR \$500. THESE LIMITATIONS SHALL APPLY NOTWITHSTANDING ANY FAILURE OF ESSENTIAL PURPOSE OF ANY REMEDY. WITHOUT LIMITING ANY OTHER CONDITION SET FORTH IN THIS SECTION, MATTERPORT WILL HAVE NO WARRANTY OBLIGATION HEREUNDER IF YOU FAIL TO RETURN THE CAMERA IN THE UNDAMAGED ORIGINAL PACKAGING OR IF YOU HAVE INSTALLED ANY FIRMWARE IN THE CAMERA OTHER THAN THE FIRMWARE INITIALLY EMBEDDED IN THE CAMERA OR ANY FIRMWARE UPDATE SUBSEQUENTLY PROVIDED BY MATTERPORT. APPLICABLE LAW MAY NOT ALLOW THE EXCLUSION OF IMPLIED WARRANTIES, OR SOME OR ALL OF THE FOREGOING LIMITATION OF LIABILITY, SO SOME OR ALL OF THE FOREGOING DISCLAIMERS AND/OR LIMITATION MAY NOT APPLY TO YOU.

NOTHING IN THIS AGREEMENT EXCLUDES OR LIMITS OUR LIABILITY FOR DEATH OR PERSONAL INJURY ARISING FROM OUR NEGLIGENCE, OR OUR FRAUD OR FRAUDULENT MISREPRESENTATION, OR ANY OTHER LIABILITY THAT CANNOT BE EXCLUDED OR LIMITED BY LAW.



Matterport Immersive Media Platform™ Essential User Guide: Matterport Pro2 3D Camera™ MC250

Matterport, Inc.
 352 East Java Drive
 Sunnyvale, CA 94089 U.S.A.
 matterport.com
 support.matterport.com

1 Safety

Before using the camera, please ensure that you read and understand the safety precautions described below. Always ensure that the camera is operated correctly.

Keep these safety instructions where all those who use the product will read them.

! WARNINGS

Do not open or disassemble the camera. The camera contains no user-serviceable parts inside.

This product contains a Li-ion battery. Do not attempt to open or service the battery. Batteries are only intended to be removed by a professional.

Use only the included power supply. Do not use with a power converter/transformer.

2 Notices

This symbol indicates that electrical and electronic equipment is to be collected separately. The following apply only to users in European countries:

- This product is designated for separate collection at an appropriate collection point. Do not dispose of as household waste.
- Separate collection and recycling helps conserve natural resources and prevent negative consequences for human health and the environment that might result from incorrect disposal.
- For more information, contact the retailer or the local authorities in charge of waste management.
- Matterport will not be held liable for any damages resulting from the use of this product.
- While every effort has been made to ensure that the information in these manuals is accurate and complete, we would appreciate it were you to bring any errors or omissions to the attention of Matterport Customer Support at support.matterport.com.

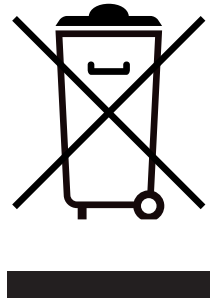

This symbol on the battery indicates that the battery is to be collected separately. The following apply only to users in European countries:

- All batteries, whether marked with this symbol or not, are designated for separate collection at an appropriate collection point. Do not dispose of as household waste.
- For more information, contact your Matterport Local Reseller or the local authorities in charge of waste management.

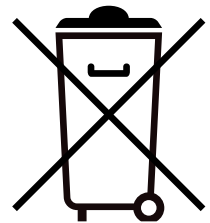

3 Introduction

MATTERPORT PRO2 3D CAMERA

The Matterport Pro2 3D Camera reliably captures all the data needed to create immersive 3D Spaces from the real world.

Though it is a complex instrument for capturing visual (RGB) and depth data, the camera is easy to use, as most of the operation has been automated to ensure consistent scan results with every use.

The Matterport Pro2 3D Camera consists of an array of three sensors mounted on a motor which rotates the camera 360° to capture the RGB and depth data needed to create a 3D replica of a real-world location.



Items included:

- 1 – Matterport Pro2 3D Camera, MC250 Series
- 1 – Power Supply for MC250

Other required items (not included):

- Tripod with 3/8-16 mount rated for minimum load capacity of 4.5 kg (10 lbs) - Recommended tripods can be found on matterport.com/tripods
- Matterport Capture for iOS may be downloaded free from the iTunes store
- Compatible with Apple iPad™ - A current list of compatible iPads can be found on matterport.com/ipads
- Quick-release base such as the Sunwayfoto MAC - 14 Arca Clamp
- For use outside the U.S., a plug adapter may be needed for the power supply

Optional recommended items (not included):

- Other current Matterport User Guides can be found at matterport.com/user-guides
- Padded carry case or bag

4 Camera Diagram

FRONT VIEW

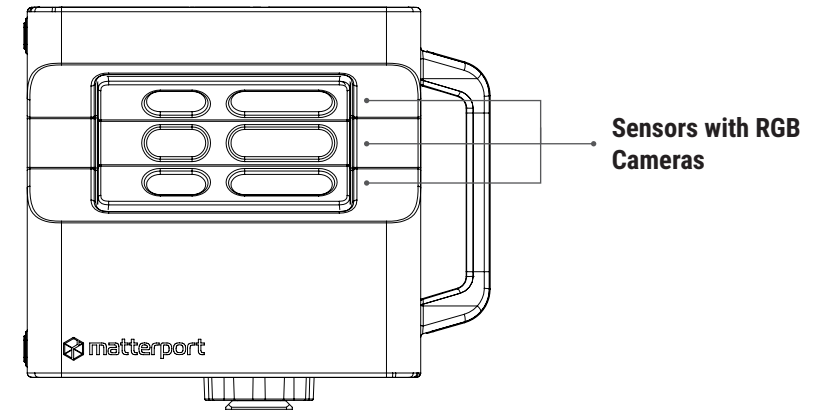

REAR VIEW

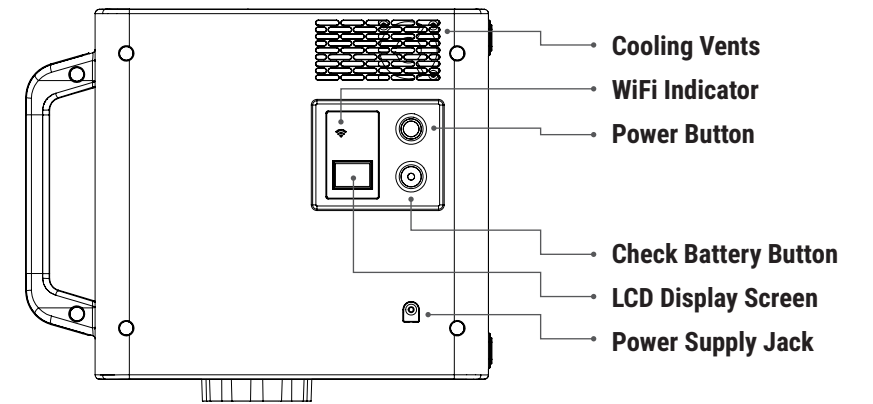

BOTTOM VIEW

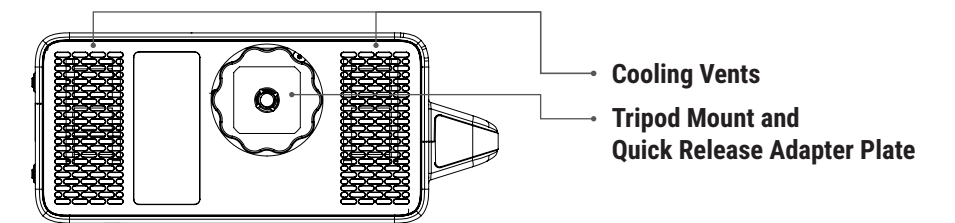

Symbols used on the camera



LCD Display messages

If the LCD Display reports "Boot Timed Out" or any type of "Fault", please contact support.matterport.com. This occurs rarely, but once it occurs, it can indicate a potentially serious problem. Rebooting may or may not fix the error. The camera may no longer function until repaired.